

### **INSTALLATION DETAILS**

- Recommended crew (Adult): 2
- Installation time: **4-8 Hours (8-16 total man hours)**
- User age: **2-5 Years**
- Use zone: **9'3" x 5'11"**
- Weight: **1,700**

### **MAINTENANCE**

As the owner of the play equipment you are responsible for maintenance of the equipment and play area. A maintenance schedule must be developed and the equipment inspected frequently.

A maintenance section is included at the end of this manual. Make copies of the original maintenance section that is included with this manual for documenting all inspections and corrective actions and keep those documents on file. Contact distributor for replacement parts.

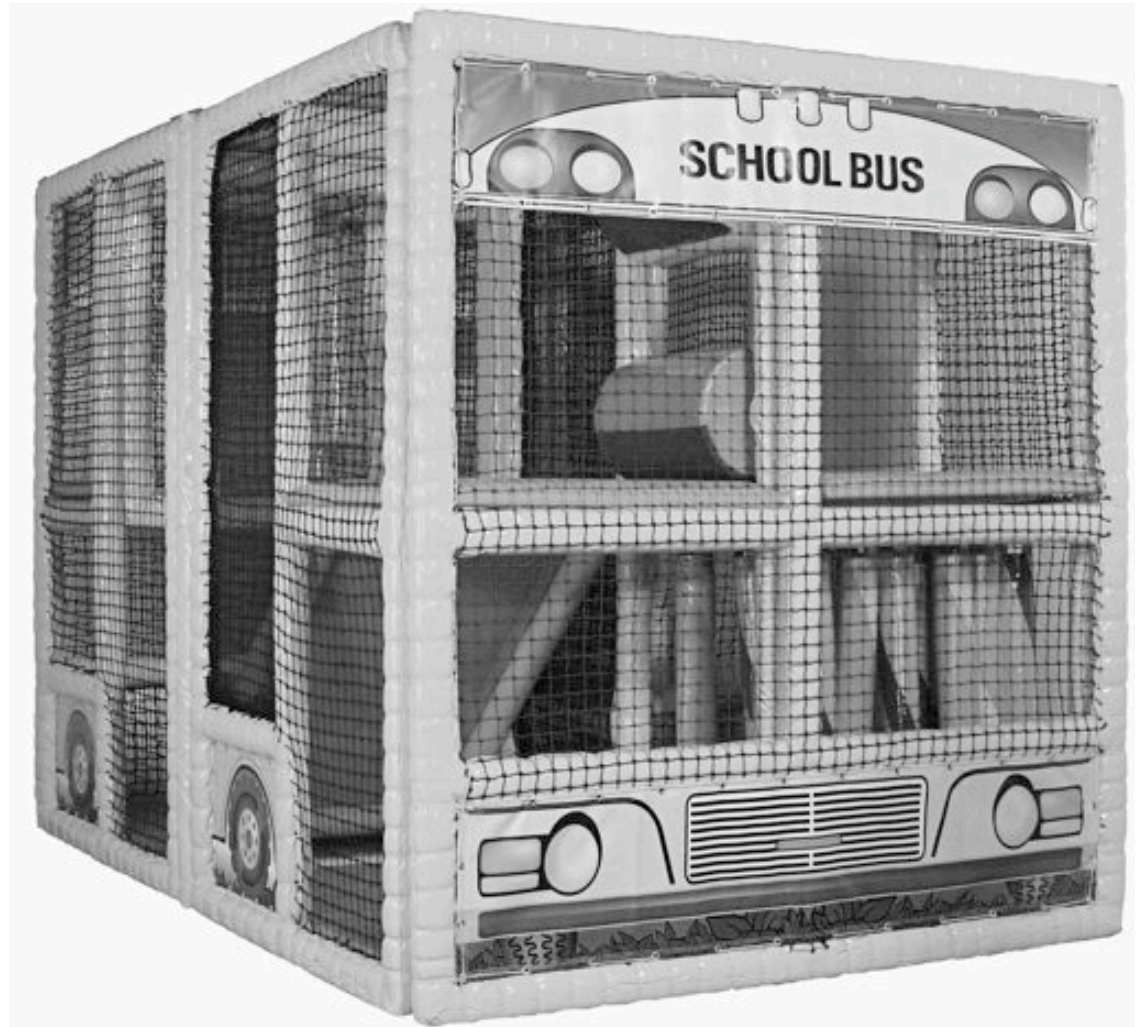



**902-796 SCHOOL BUS CONTAINED PLAY  
INSTALLATION INSTRUCTION**

**PARTS LIST**

<b>ID</b>	<b>DESCRIPTION</b>	<b>QTY</b>
1	Panel 1	1
2	Panel 2	1
3	Panel 3	1
4	Panel 4	1
5	Panel 5	1
6	Panel 6	1
7	Panel 7	1
8	Panel 8	1
9	Panel 9	1
10	Panel 10	1
11	Bar 1	1
12	Bar 2	1
13	Double Connector	12
14	Triple Connector	6
15	Deck 1	1
16	Deck 2	1
17	Deck 3	1
18	Deck 4	1
19	Deck 5 (Slide)	1
20	Deck 6	1
	Tot Boppers	19
	Large Bopper	1
	Bopper Rail	3
	Mat	4
	Net	1

**NOTE:** Keep a copy of these instructions on file to assist you with maintenance and replacement parts.

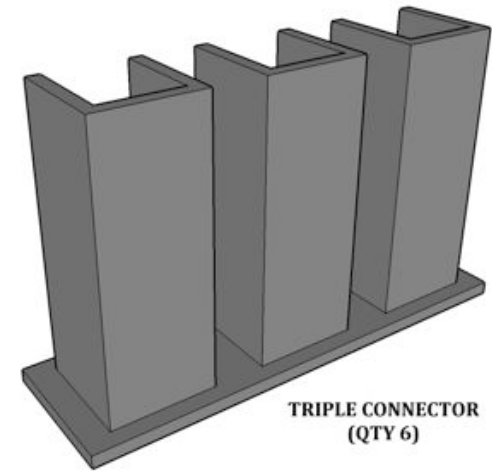
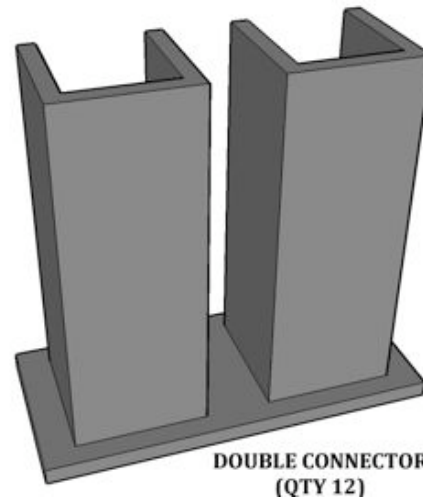

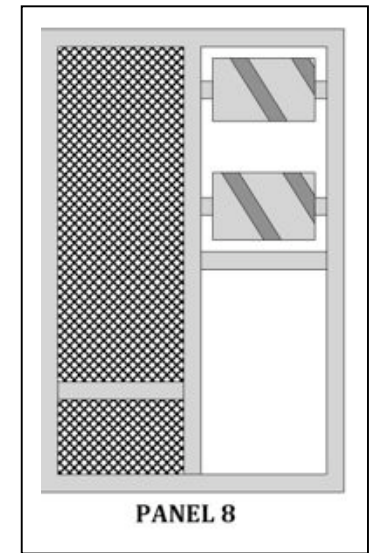
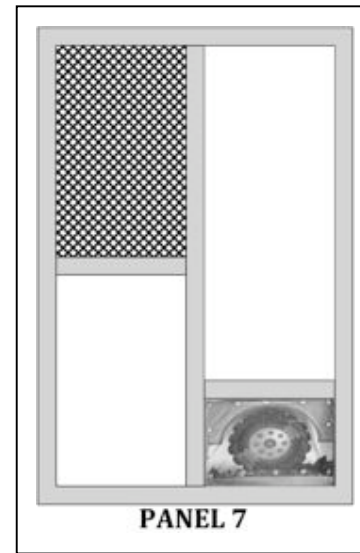
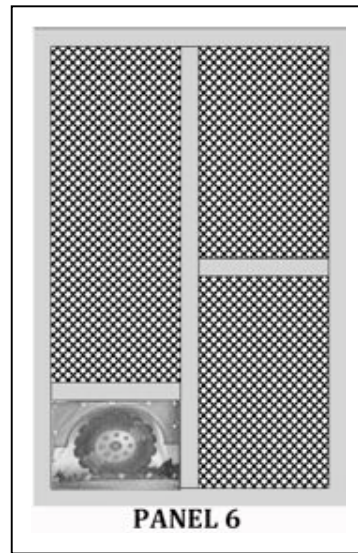
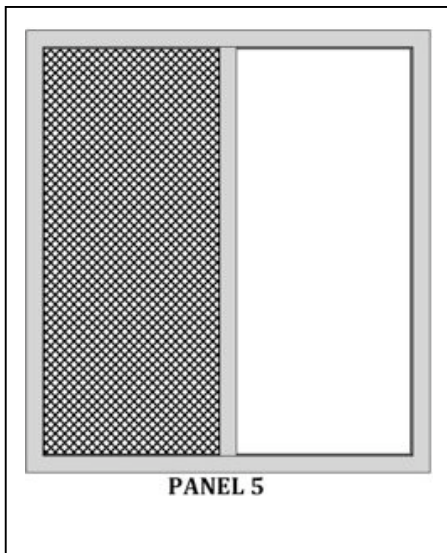
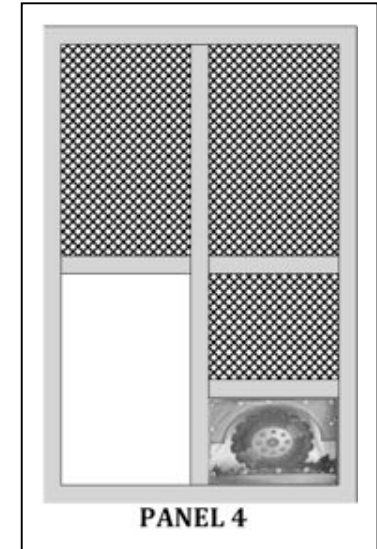
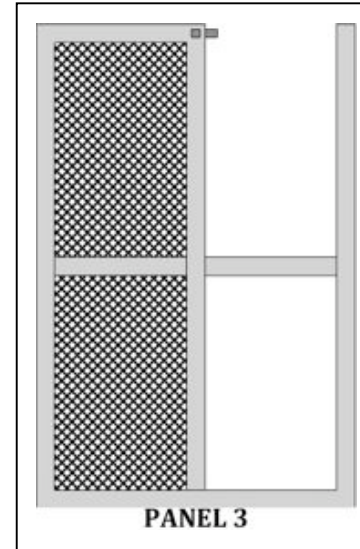
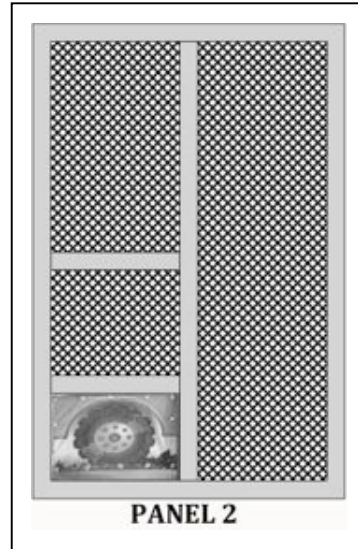
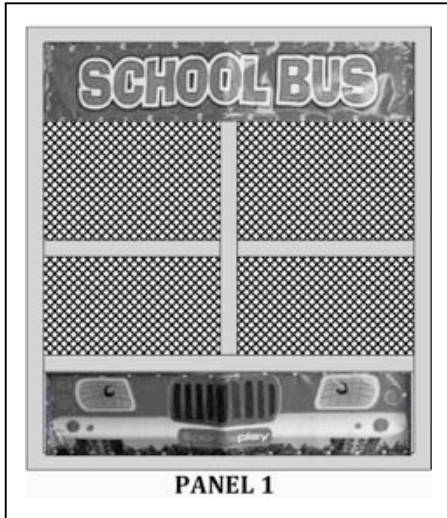

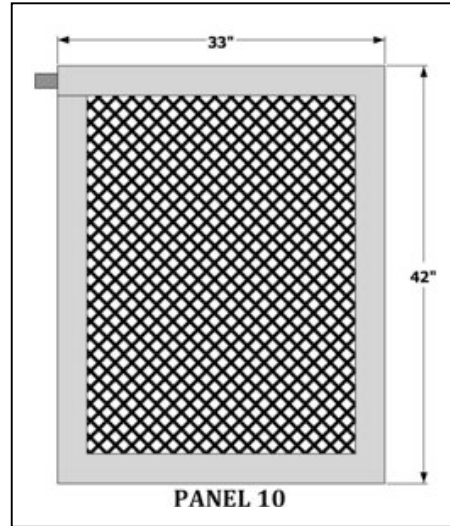

**DECK 1**



**DECK 2**



**DECK 3**



**DECK 4**



**DECK 5 (SLIDE)**



**DECK 6**

IMPORTANT INFORMATION BEFORE YOU BEGIN

- When the instructions call for you to use a Double or Triple Connector be sure to install that bracket at the bottom of the panel before you install it in the top.
- There are 19 Tot Boppers and you are free to configure the quantities at each location, as you desire.
- Refer to the various drawings of the panels and assembly throughout the installation to prevent having to take a panel off and move it later.
- This unit is designed for indoor use. Installing this product outdoors could cause damage from sunlight and weather. Additionally by installing this unit outdoors the weather could make certain parts of this unit unsafe.
- This unit is designed for children ages 2-5.
- Have children remove their shoes, clothes with strings or hoods and any other accessories that could become tangled potential causing injury.
- Adult supervision is required when in use. Failure to do so could result in severe injury or even death.

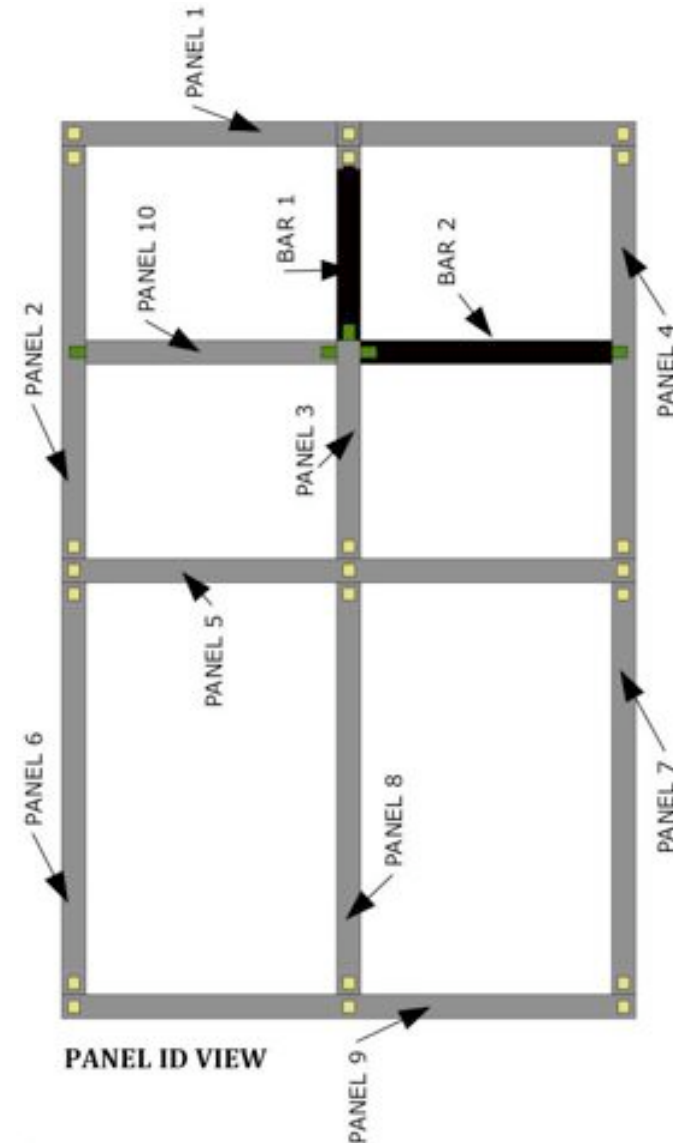

**INSTALLATION INSTRUCTIONS**

1. Connect panel's 1 and 2 by first inserting a Double Connector into the bottom of panel 1 at all 3 locations. (Panel 1 represents the front of the unit, to ensure proper configuration position panel 1 so that the graphics are facing out. You should always verify the panel is correct by referencing the images on pages 3 and 4). Once bottom connectors are installed attach panel 2 to the proper bottom connector (install a Triple Connector into the bottom of panel 2 where it will connect to Panel 5) and then connect the top of panels 1 & 2 by installing a Double connector at the top. (see detail 1).
2. Attach panel 3 to Panel 1 following the same procedure in step 1 (reference detail 1).
3. Next install Panel 10 by first spreading out the back end of panels 2 & 3. Slide the male fitting at the top of panel 10 into the female opening at the top (middle) of panel 2. Insert the male fitting on the top of panel 3 into the female opening in panel 10. Bolt panel 10 by inserting a bolt through the bottom of the bracket on panel 3 and into the bottom of panel 10. (see detail 2).
4. Attach panel 4 to panel 1 following the same procedure in step 1. (Refer to details 1 and 3)

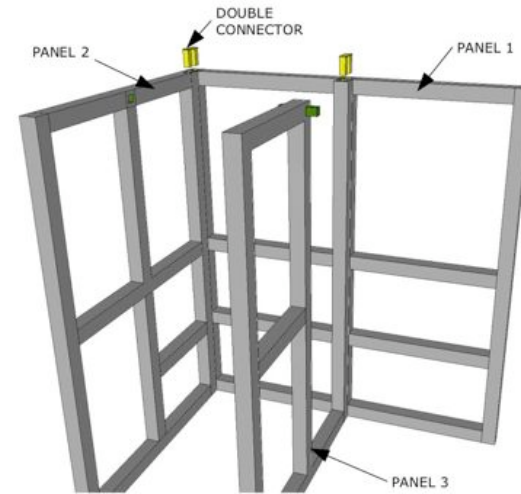

DETAIL 1

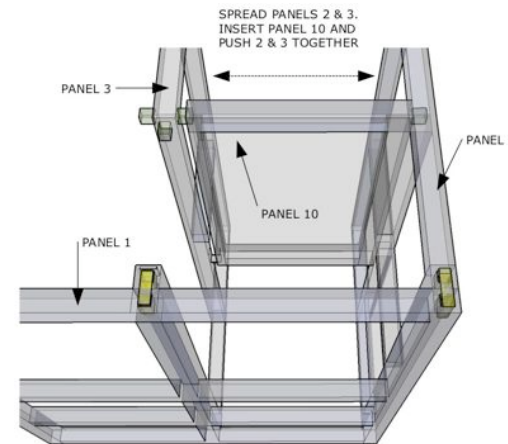

DETAIL 2

5. Before attaching Bar 2, slide the Large tot Bopper onto the bar. Attach Bar 2 to the top of panels 3 & 4 by first pushing panel 4 out and sliding the male fitting from panel 3 into the female cutout in Bar 2 and then sliding the male fitting in Bar 2 into the female cutout on panel 4. (see Detail 3).
6. You should have put triple connectors into the bottom of panels 2, 3 & 4. Next install Panel 5 by sliding it over the triple connectors on the back end of panels 2, 3 & 5. (refer to detail 4 on the next page). **DO NOT INSTALL THE TRIPLE CONNECTORS AT THE TOP UNTIL YOU HAVE FINISHED INSTALLING PANELS 6, 7 & 8 IN STEP 7.**

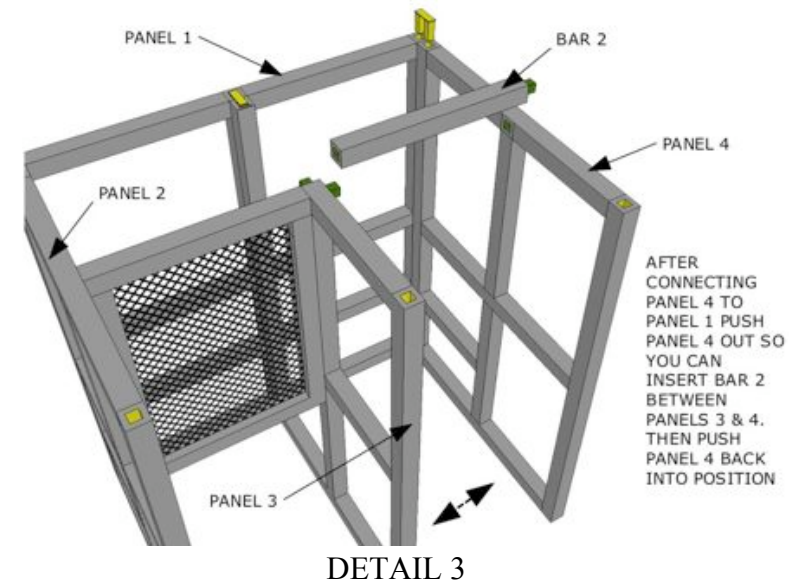

7. Following the Procedures in step 1 attach panels 6, 7 & 8 to panel 5. **BE SURE TO INSTALL THE DOUBLE CONNECTORS IN THE BOTTOM OF PANELS 6, 7 & 8.** (see Detail 4)
8. Referencing Detail 5, slide 15 Tot boppers (in any desired configuration) onto the three Bopper Rails. Then push panels 7 and 8 apart and insert the bopper rails. Once attached push the panels back together.

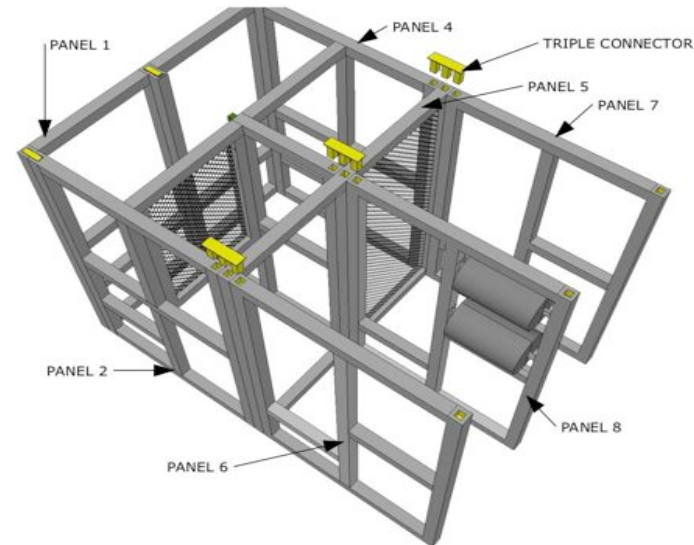

**DETAIL 4**

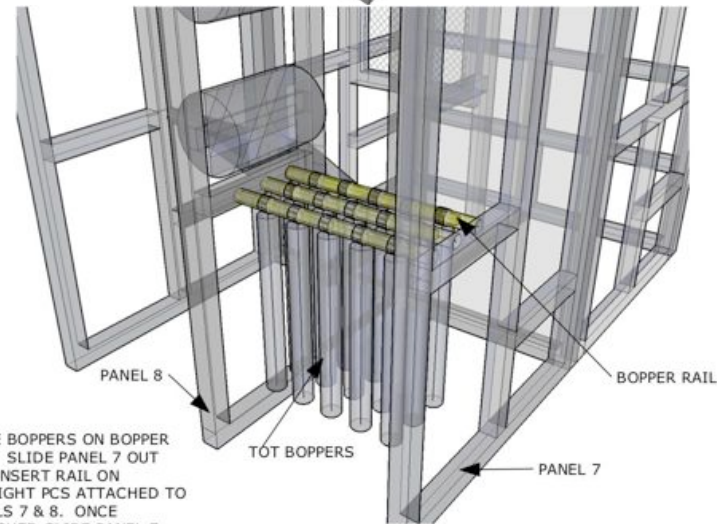

**DETAIL 5**

SLIDE BOPPERS ON BOPPER RAIL. SLIDE PANEL 7 OUT AND INSERT RAIL ON STRAIGHT PCS ATTACHED TO PANELS 7 & 8. ONCE ATTACHED SLIDE PANEL 7 BACK INTO PLACE.



9. Insert the slide into position between panels 2 & 3 and panels 6 & 8. The high end of the slide fits between panels 6 & 8 and the tabs on the slide fit into the pockets on panels 6 & 8. (Refer to detail 6 and the slide to panel detail)
10. Next, slide panel 9 over the Double Connectors on the ends of panel's 6, 7 & 8. Then insert Double connectors into the top of panel 9 in order to connect it to panels 6, 7 & 8. (Refer to Detail 7)

SEE SLIDE DETAIL FOR DETAILED IMAGE OF ATTACHMENT. INSERT THE HIGH END OF THE SLIDE BETWEEN PANELS 6 & 8. THE LOW (EXIT) END OF THE SLIDE WILL SIT BETWEEN PANELS 2 & 3

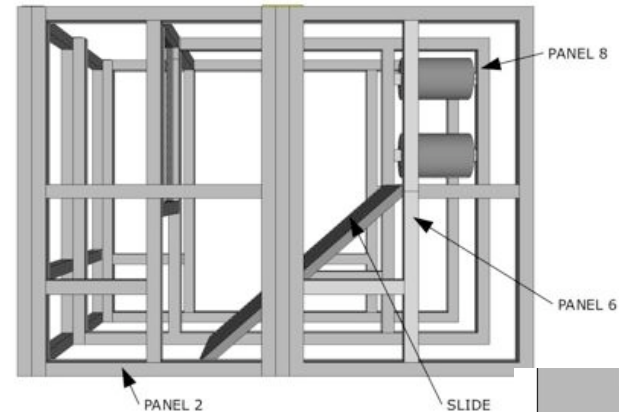

**DETAIL 6**

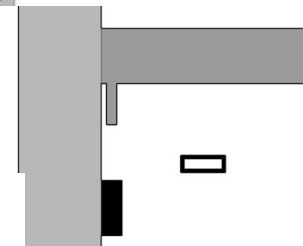

**SLIDE TO  
PANEL**

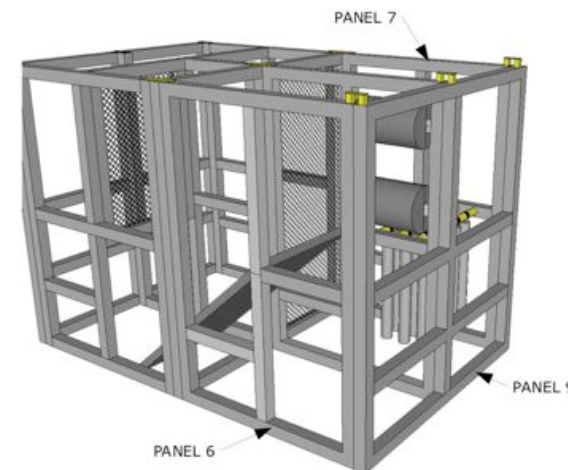

**DETAIL 7**

11. Attach Bar 1 to panels 3 and 1 by first sliding 4 Tot Boppers onto Bar 1 and then inserting the male fitting on panel 3 into the bar and then sliding the tab on the bar into the pocket on panel 1. (Refer to detail 8)

SLIDE TOT BOPPERS ONTO BAR 1. NEXT TILT BAR 1 BACK AND SLIDE IT OVER THE STUB ON PANEL 3. THEN INSERT THE FRONT TAB INTO THE SLOT ON PANEL 1.

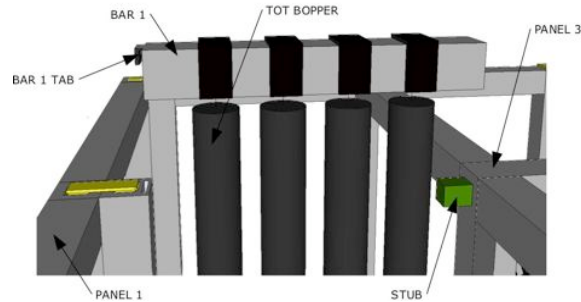

**DETAIL 8**

12. Using this drawing as a reference, install the decks (note: Deck 5 (slide) is already installed).

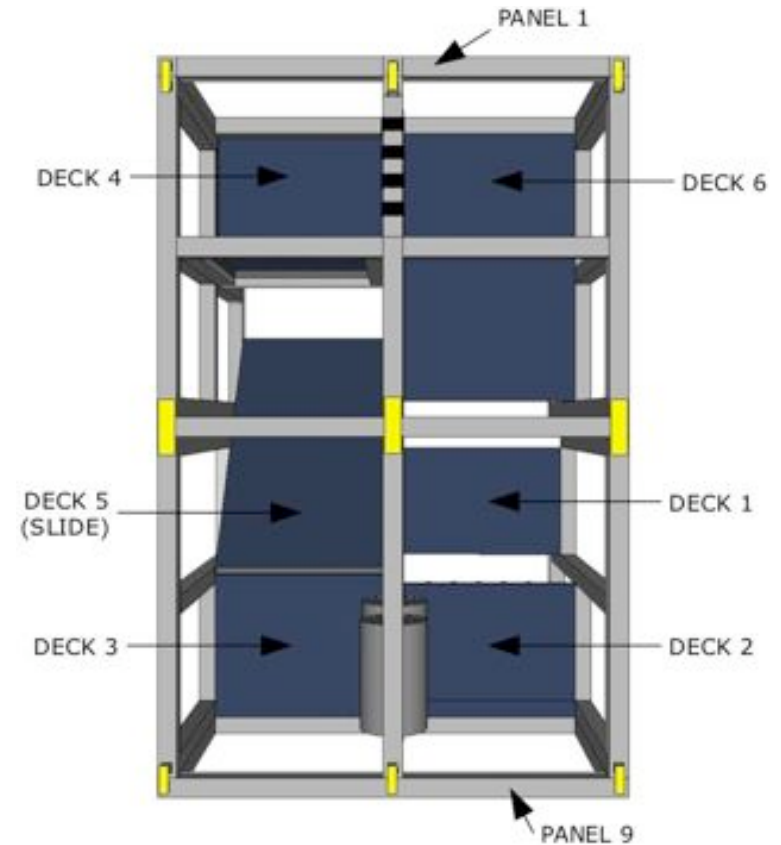



13. Once all parts are installed you may install the mats and the top net. Secure net with included ties. Ensure all connections are secure and there are no gaps between panels and decks. Refer to the drawings on the next page to ensure proper installation.

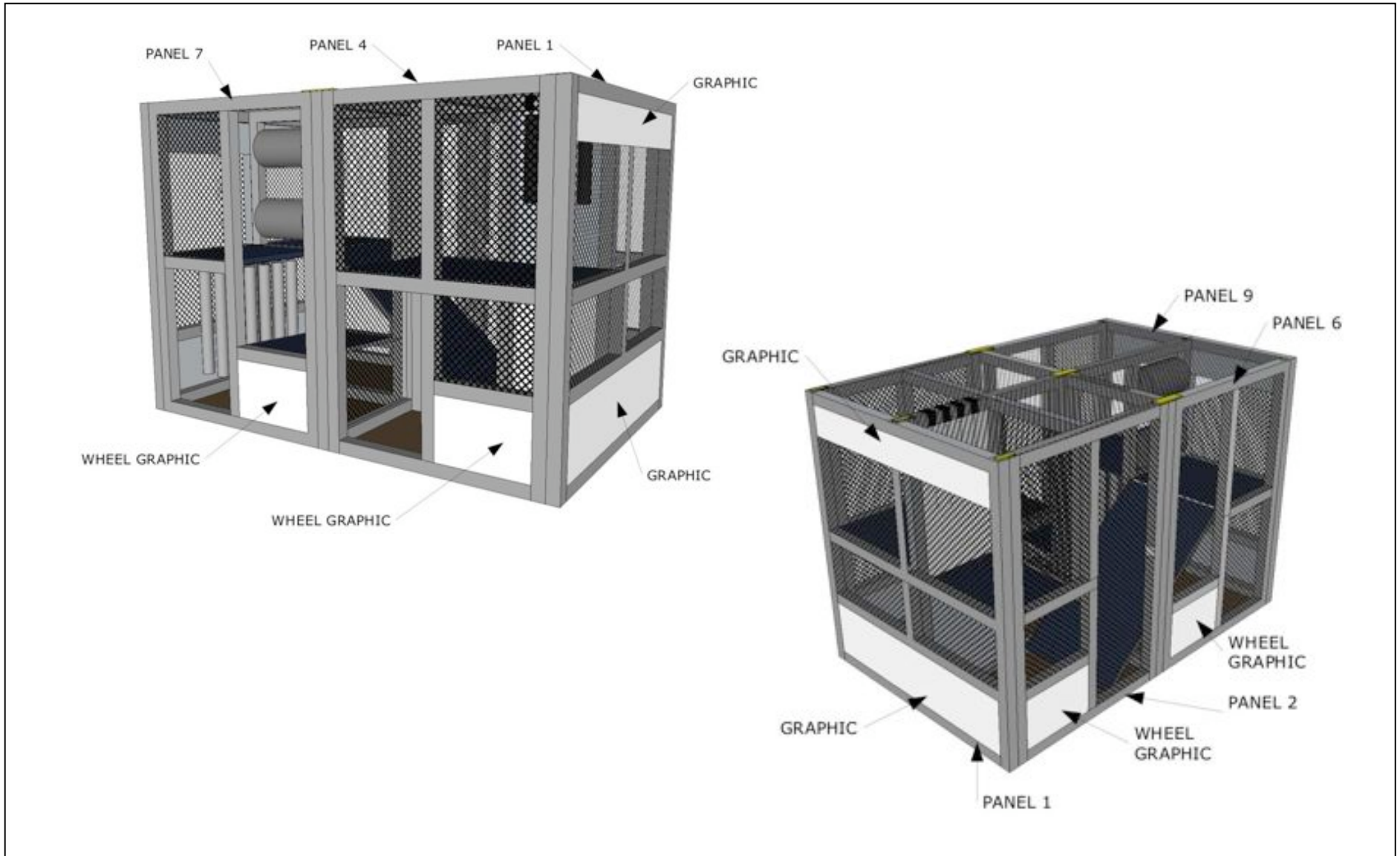

### **Connectors**

- Inspect all connectors and netting/graphic attachments.
- Ensure there are no missing or worn connectors or ties
- Take the unit out of service and contact your distributor for replacements.

### **Hardware**

- Inspect for loose or missing hardware. Tighten all loose hardware and replace all missing hardware. Block off access to equipment if necessary.

### **Panels/Decks**

- Inspect all components for cracks. If a crack is found block access to the playground and contact your distributor for replacement parts immediately.
- Inspect for gaps and/or entrapments.
- Replace if missing or damaged

### **Finish**

- If wrapping is damaged you may repair with glue or industrial tape. If damaged beyond repair contact your distributor for a replacement piece.

### **Replacement Parts**

- Reference the parts list on page 2 of the instruction set for this component to identify the part/s correctly.
- Contact your distributor to order parts.



